

Product data sheet

Characteristics

9070T150D4

Transformer, Type T, industrial control, 150 VA,
277 VAC primary / 120 VAC secondary, 1 phase,
50/60 Hz, 55 °C rise



Product availability: Stock - Normally stocked in distribution facility

Price*: 230.00 USD



Main

Product or component type	Industrial Control Transformer
Rated power in VA	150 VA
Range of product	T

Complementary

Phase	1 phase
Rated power in VA	150 VA
Temperature rise	55 °C
Electrical connection	Screw clamp terminals
Height	3.2 In (81.28 mm)
Width	3.75 In (95.25 mm)
Depth	3.59 In (91.19 mm)
Material	Copper winding
Product compatibility	FSC1

Environment

Product certifications	UL listed file E61239 CSA file LR37055 guide 184-N-90
NEMA degree of protection	Not rated (open device)
Insulation temperature	221 °F (105 °C)

Ordering and shipping details

Category	16200 - 9070 T (NOT TF) 50-200VA
Discount Schedule	CP8
GTIN	00785901905707
Nbr. of units in pkg.	1
Package weight(Lbs)	5.57 Lb(US) (2.527 kg)

Returnability	Yes
Country of origin	MX

Packing Units

Unit Type of Package 1	PCE
Package 1 Height	4.00 In (10.16 cm)
Package 1 width	4.20 In (10.668 cm)
Package 1 Length	3.70 In (9.398 cm)

Offer Sustainability

Sustainable offer status	Green Premium product
California proposition 65	WARNING: This product can expose you to chemicals including: Phenyl glycidyl ether, which is known to the State of California to cause cancer and birth defects or other reproductive harm. For more information go to www.P65Warnings.ca.gov
REACH Regulation	REACH Declaration
EU RoHS Directive	Compliant EU RoHS Declaration
Mercury free	Yes
RoHS exemption information	Yes
China RoHS Regulation	China RoHS Declaration
Environmental Disclosure	Product Environmental Profile
PVC free	Yes

Contractual warranty

Warranty	10 Years
----------	----------

Approximate Dimensions

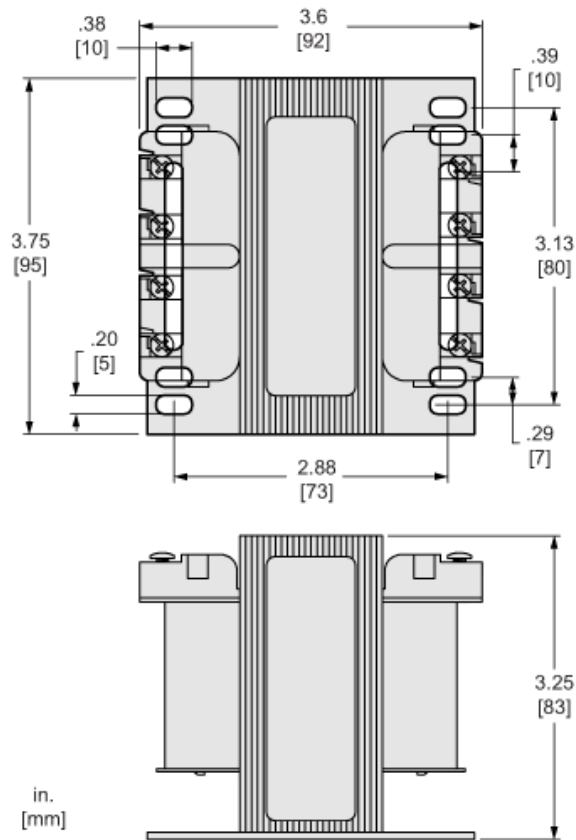

Connections and Wiring Diagrams

Voltage and Connection Options

Voltage Code	Voltages		Connections	
	Primary	Secondary	Primary	Secondary
D3	208	120	Connect to H1 and H2	Connect to X1 and X2
D4	277	120		
D5	550	110		
	575	115		
	600	120		
D6	380	110		
D17	415	110		
D24	110	110		
	115	115		
	120	120		
D93	200	115		
D103	400	120		

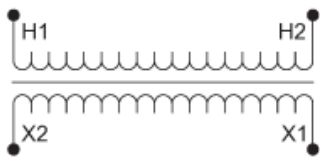

Product Life Status : **Commercialised**